

S28=S36=S40=S41=S42=S43=S45=S46=S59  
PLANTA  
ESC: 1/25

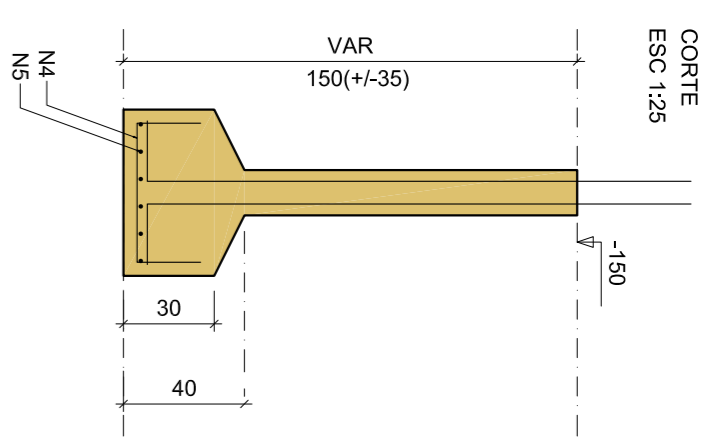

CORTE  
ESC: 1/25

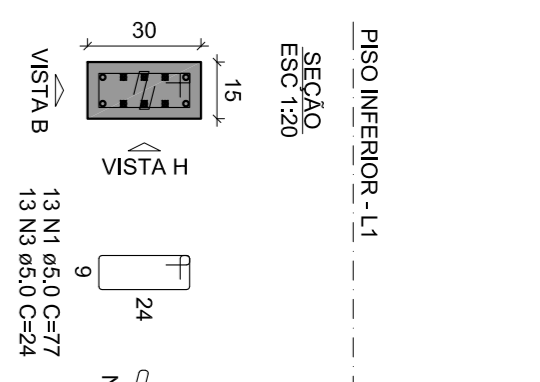

P28

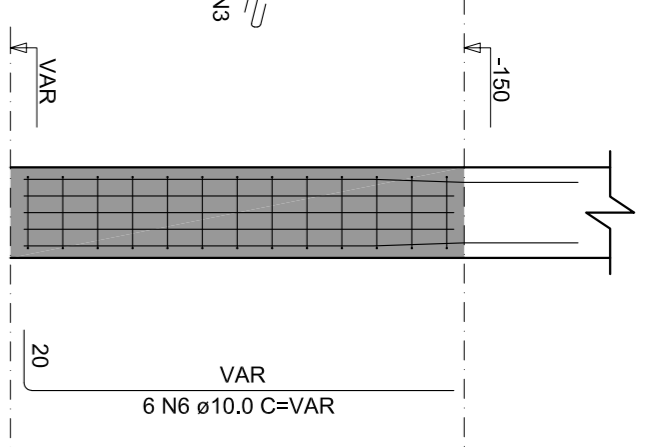

VISTA H  
ESC: 1/25

VISTA B  
ESC: 1/25

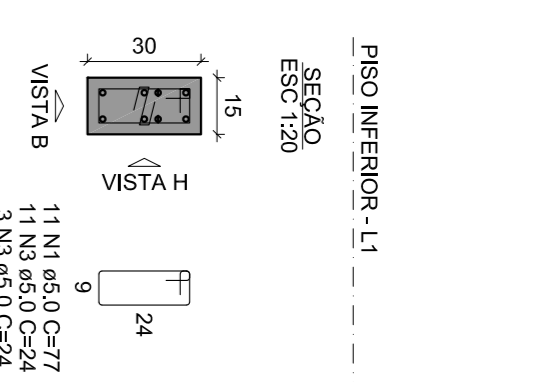

P36

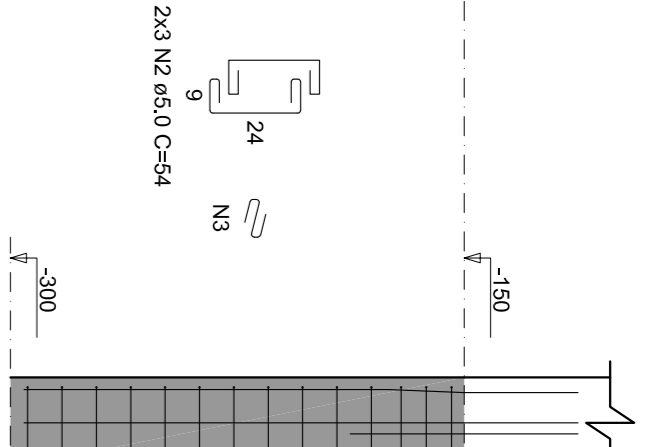

VISTA H  
ESC: 1/25

VISTA B  
ESC: 1/25

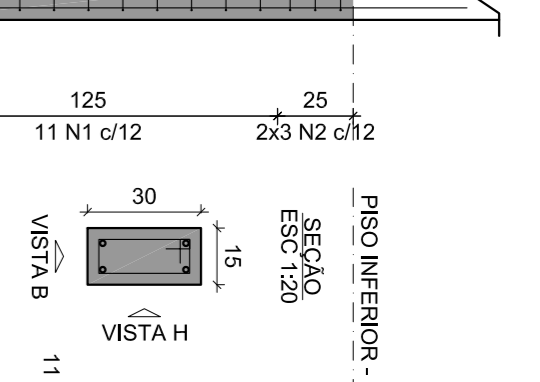

P40

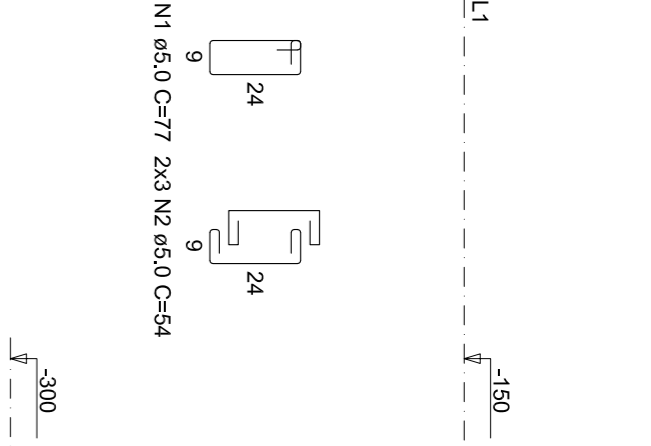

VISTA H  
ESC: 1/25

VISTA B  
ESC: 1/25

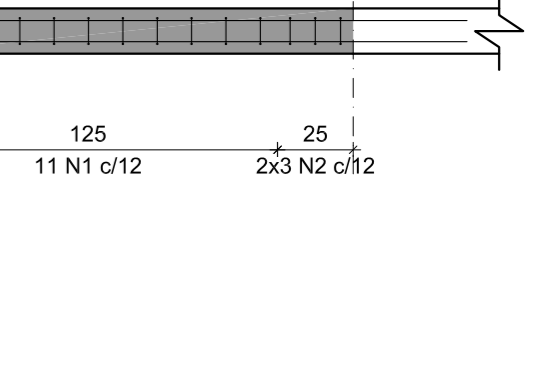

VISTA H  
ESC: 1/25

VISTA B  
ESC: 1/25

RELAÇÃO DO AÇO

ACO	N	DIAM (mm)	QUANT	C:UNT (cm)	C:TOTAL (cm)
CA60	1	5.0	161	54	4868
CA60	2	5.0	92	54	4868
CA60	3	5.0	55	24	1320
CA60	4	8.0	120	98	8810
CA60	5	8.0	26	160	4160
CA60	6	10.0	24	75	1800
CA60	7	10.0	64	205	12928
CA60	8	10.0	64	205	12928

RESUMO DO AÇO

ACO	DIAM	C:TOTAL (mm)	PESO + 10% (kg)
CA60	5.0	188.9	82.4
CA60	8.0	188.9	126.1
CA60	5.0	188.8	31.7
<b>PESO TOTAL (kg)</b>			<b>240.2</b>
CA60	210.5		
CA60	31.7		

Volume de concreto (C-25) = 2,76 m³  
Area de forma = 31,50 m²



P41

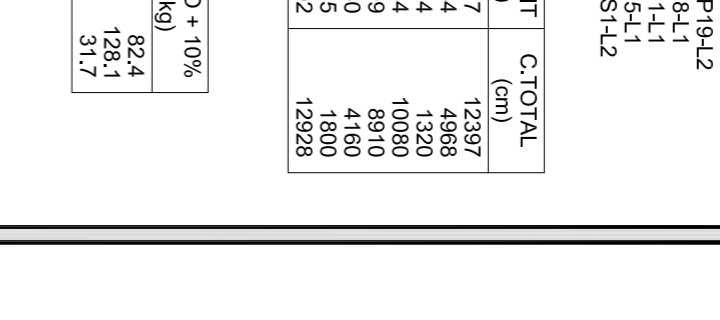

VISTA H  
ESC: 1/25

VISTA B  
ESC: 1/25

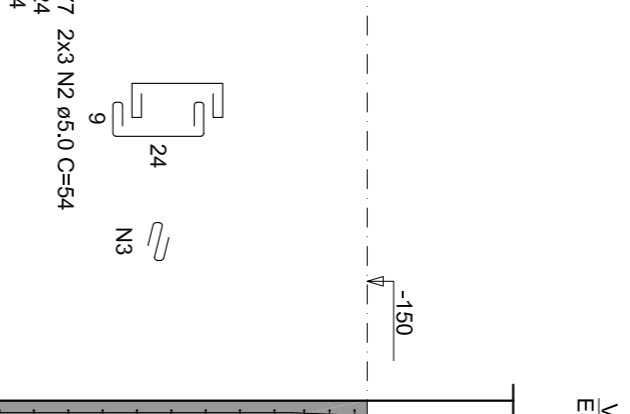

P41

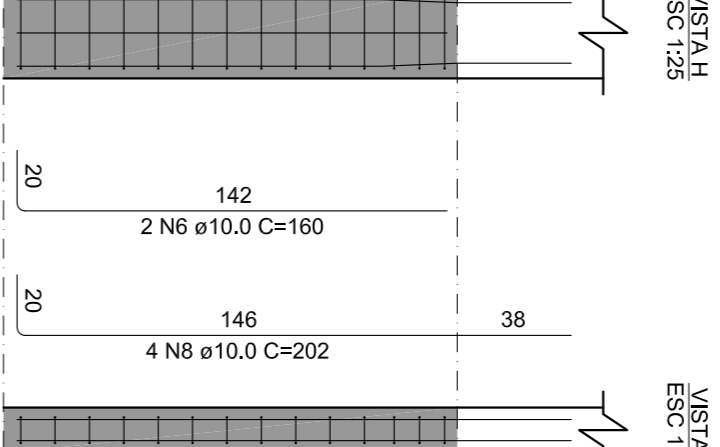

VISTA H  
ESC: 1/25

VISTA B  
ESC: 1/25

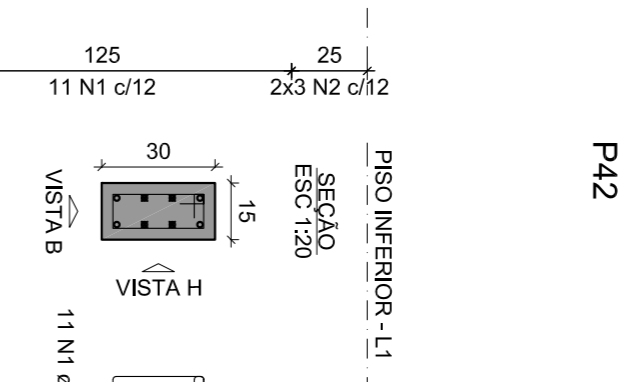

P42

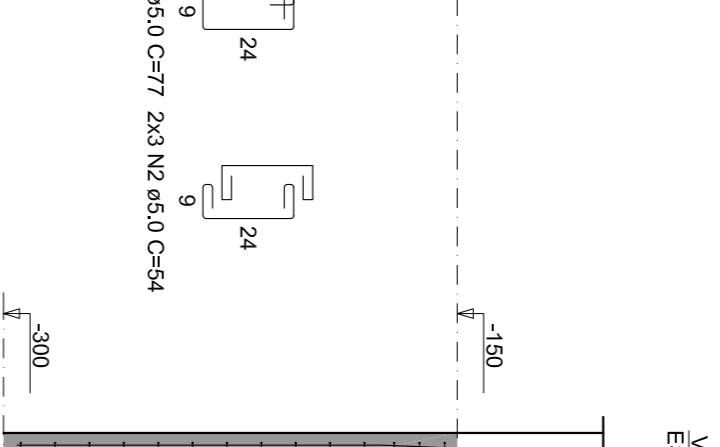

VISTA H  
ESC: 1/25

VISTA B  
ESC: 1/25

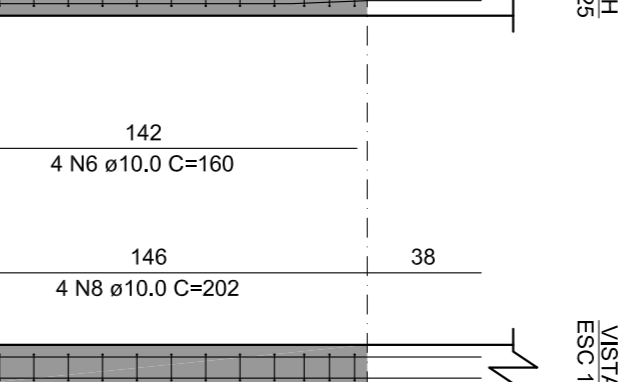

P43

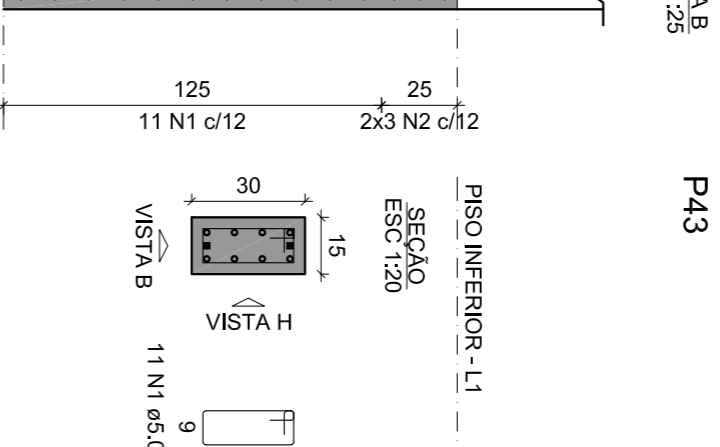

VISTA H  
ESC: 1/25

VISTA B  
ESC: 1/25

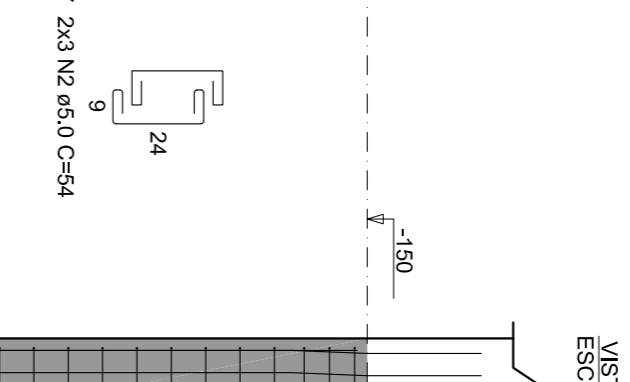

P46

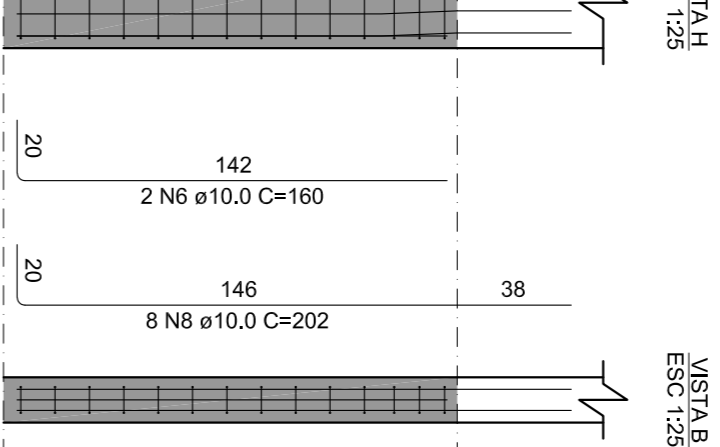

VISTA H  
ESC: 1/25

VISTA B  
ESC: 1/25

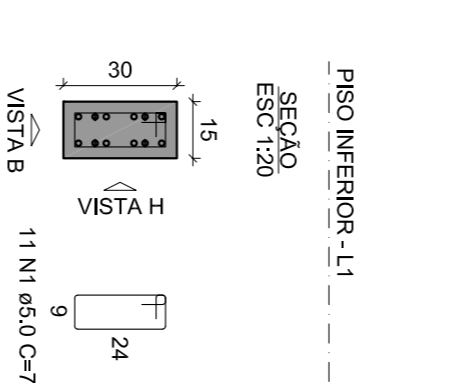

P45

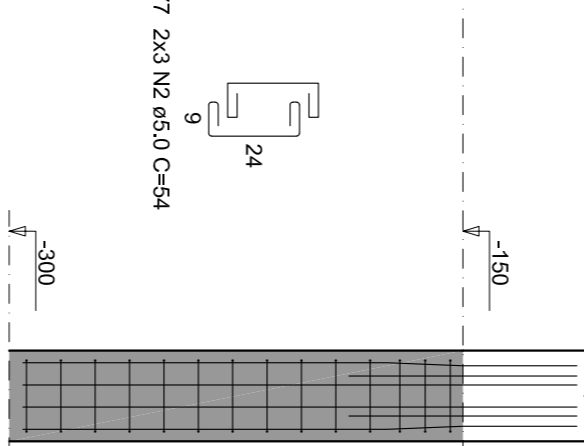

VISTA H  
ESC: 1/25

VISTA B  
ESC: 1/25

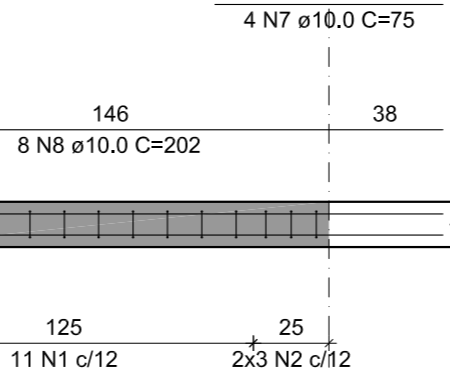

P46

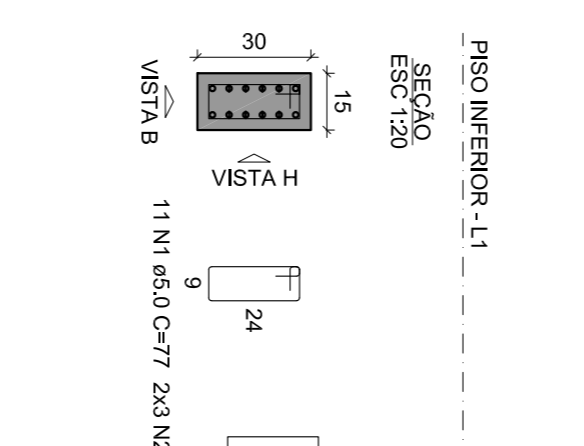

VISTA H  
ESC: 1/25

VISTA B  
ESC: 1/25

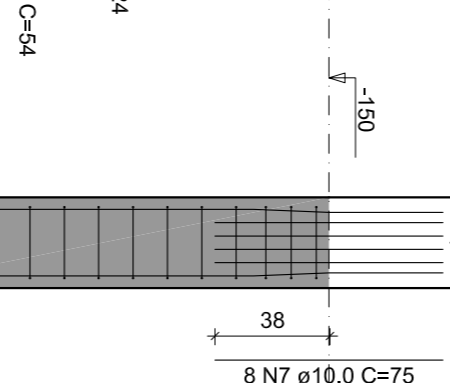

P46

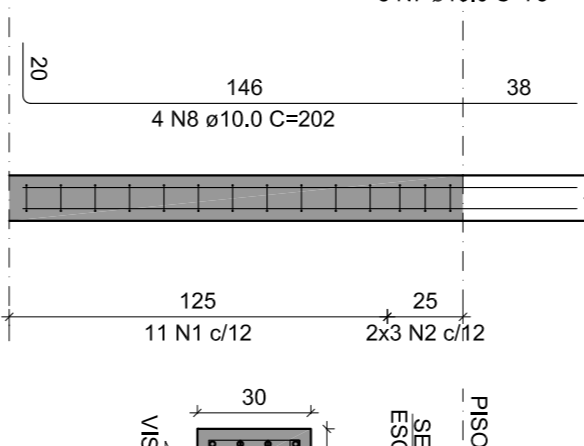

VISTA H  
ESC: 1/25

VISTA B  
ESC: 1/25

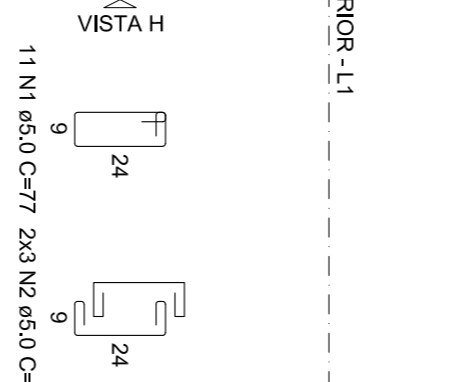

P46

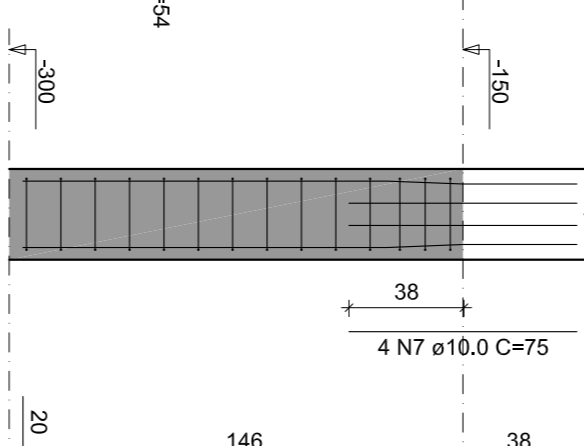

VISTA H  
ESC: 1/25

VISTA B  
ESC: 1/25

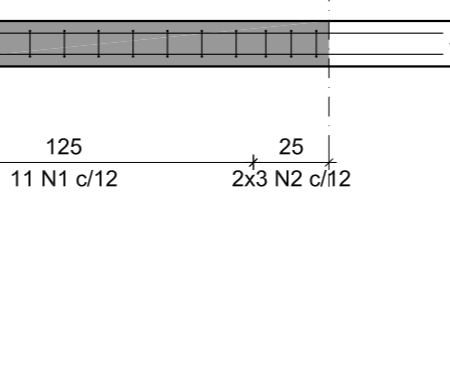

P46



VISTA H  
ESC: 1/25

VISTA B  
ESC: 1/25



P46



VISTA H  
ESC: 1/25

VISTA B  
ESC: 1/25

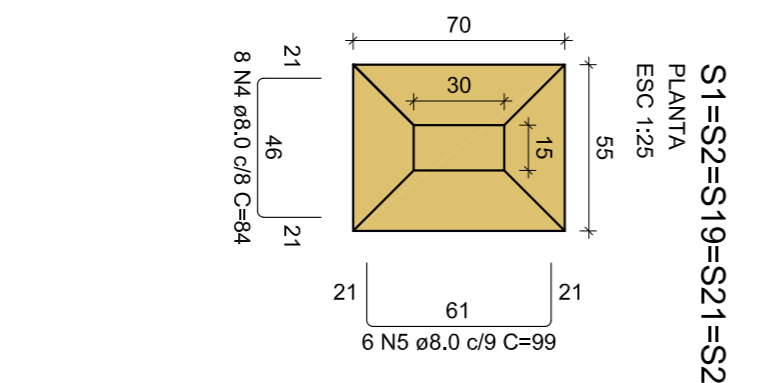

P1

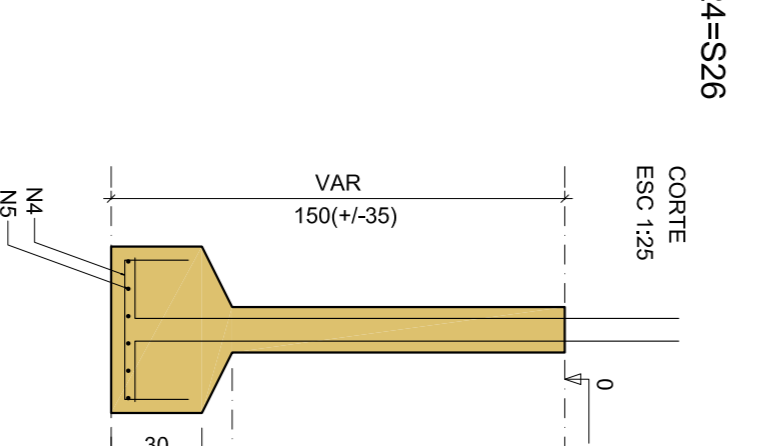

VISTA H  
ESC: 1/25

VISTA B  
ESC: 1/25

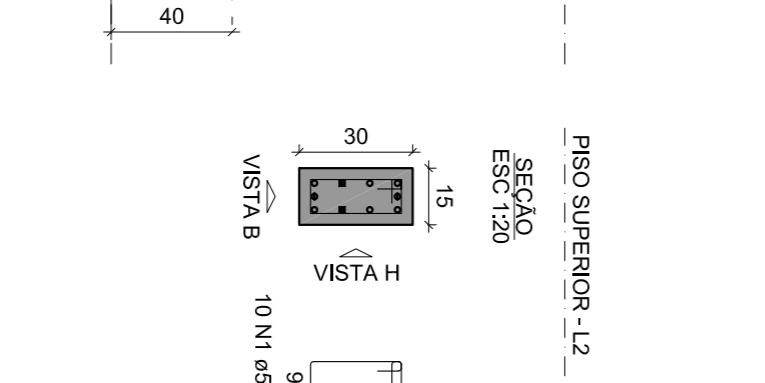

P1

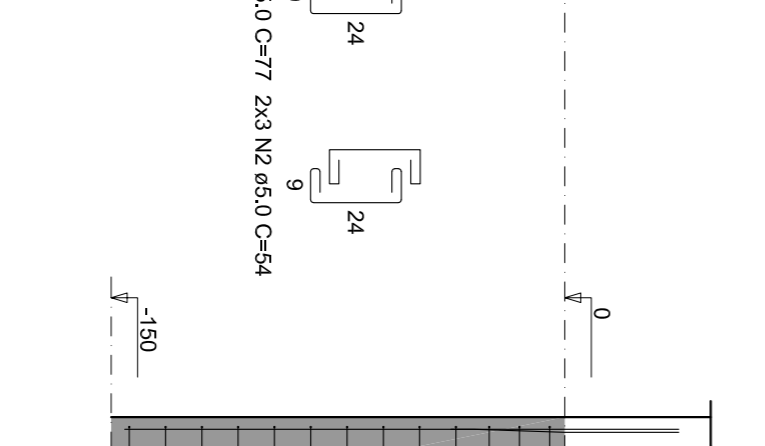

VISTA H  
ESC: 1/25

VISTA B  
ESC: 1/25

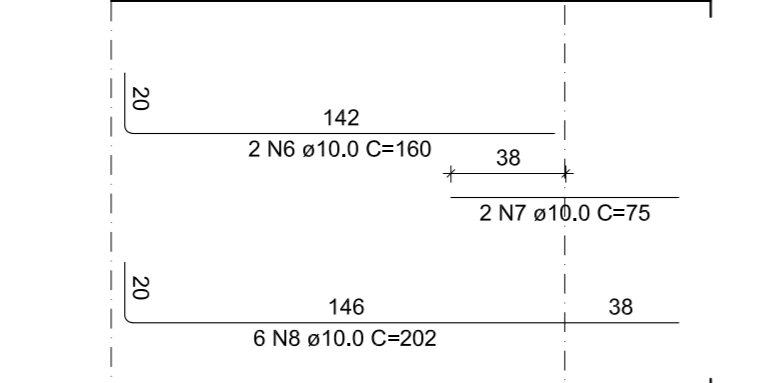

P1

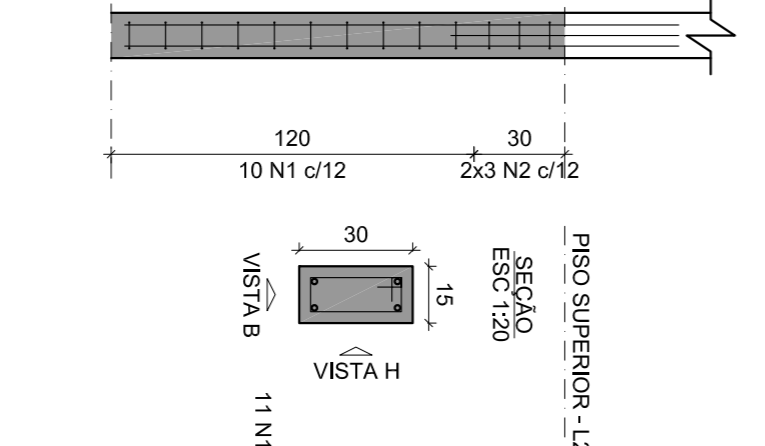

VISTA H  
ESC: 1/25

VISTA B  
ESC: 1/25

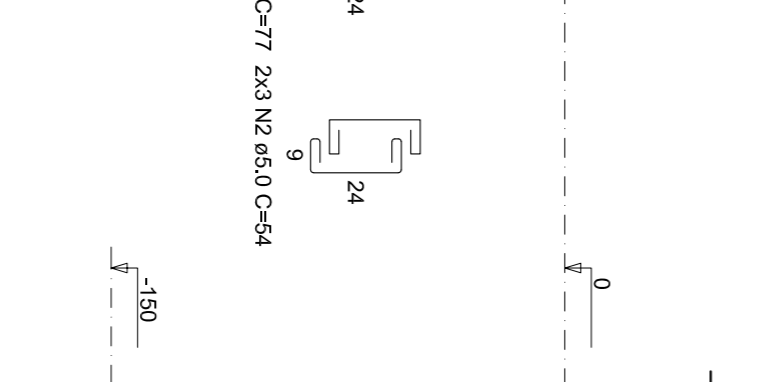

P1

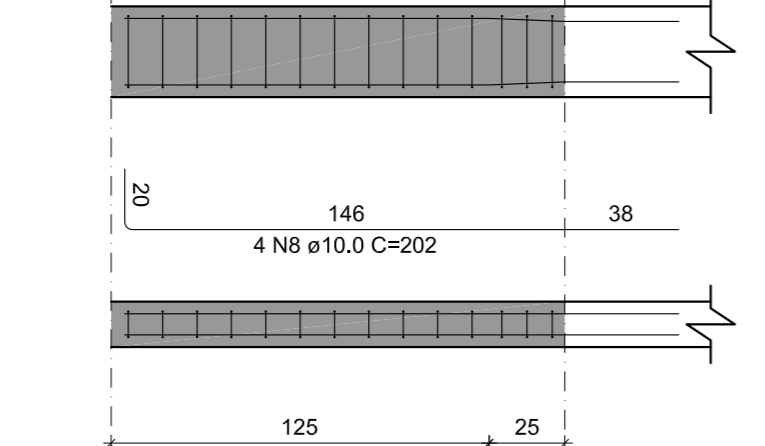

VISTA H  
ESC: 1/25

VISTA B  
ESC: 1/25



P1



VISTA H  
ESC: 1/25

VISTA B  
ESC: 1/25



P1



VISTA H  
ESC: 1/25

VISTA B  
ESC: 1/25

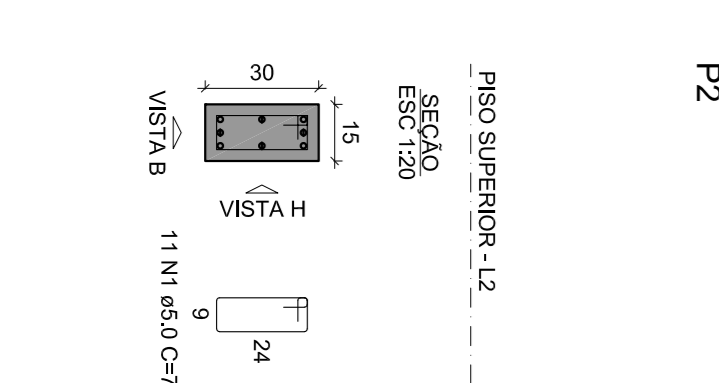

P2

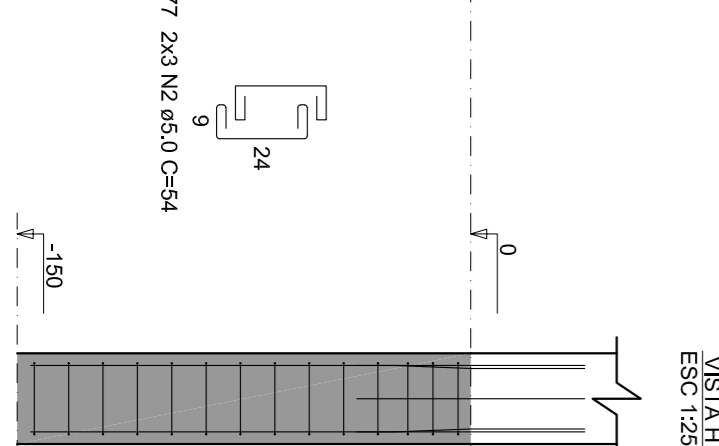

VISTA H  
ESC: 1/25

VISTA B  
ESC: 1/25

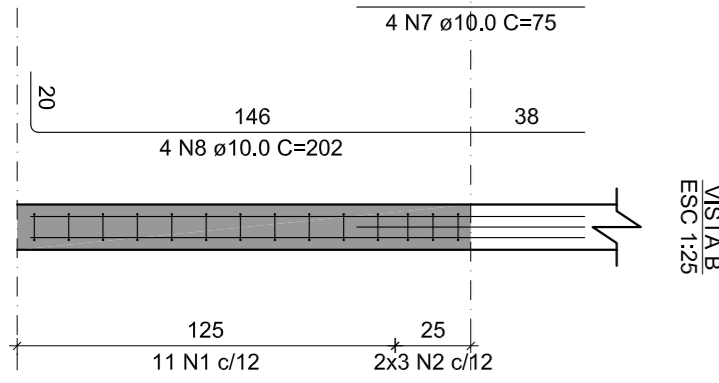

P2

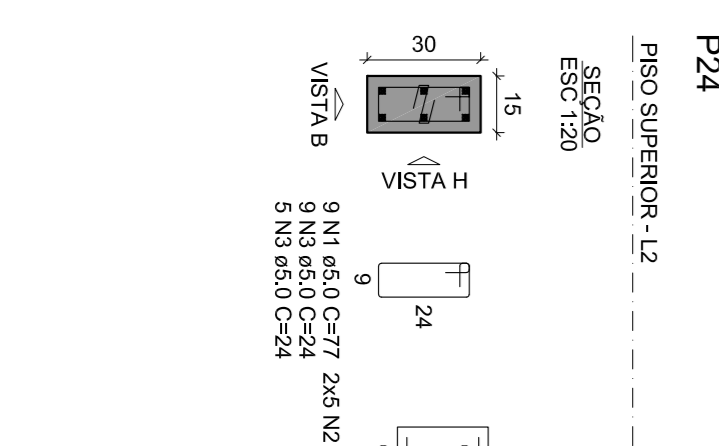

VISTA H  
ESC: 1/25

VISTA B  
ESC: 1/25

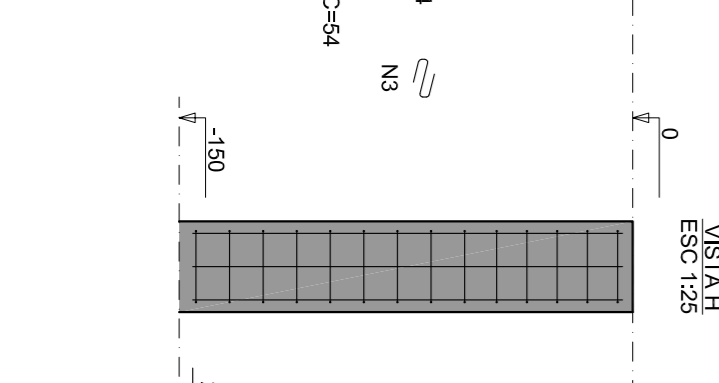

P2

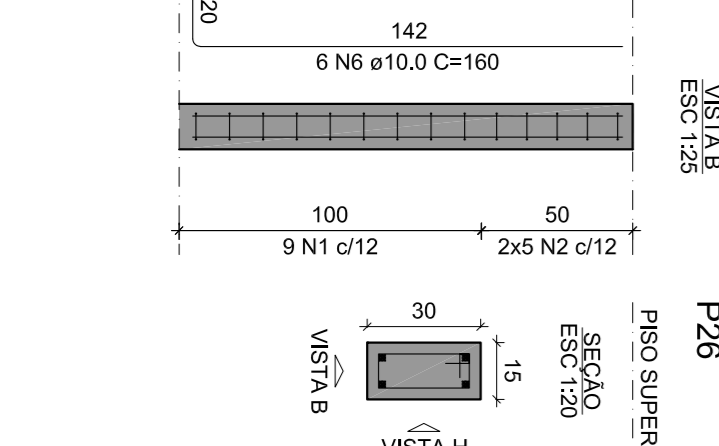

VISTA H  
ESC: 1/25

VISTA B  
ESC: 1/25

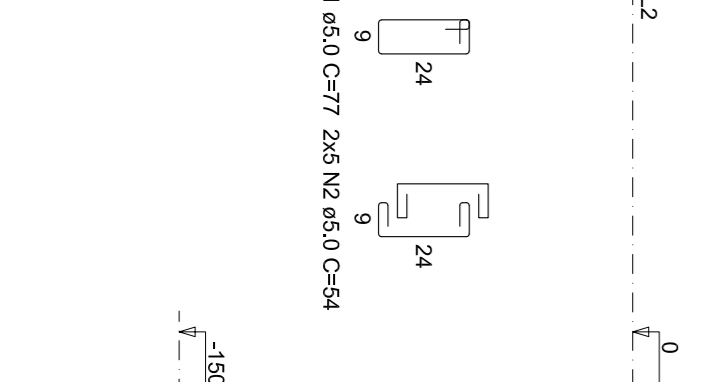

P2

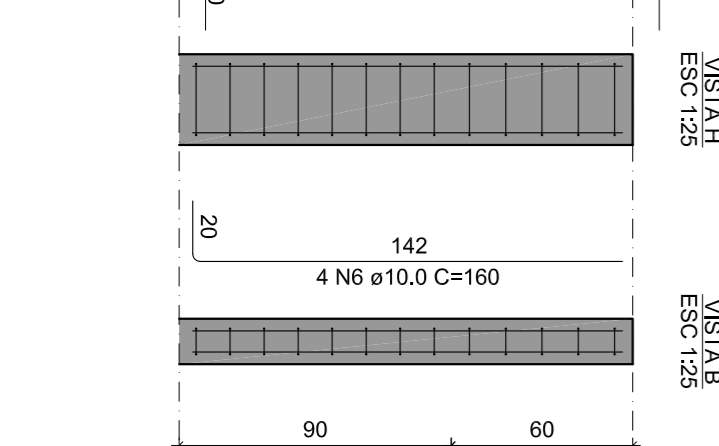

VISTA H  
ESC: 1/25

VISTA B  
ESC: 1/25



P2



VISTA H  
ESC: 1/25

VISTA B  
ESC: 1/25



P2

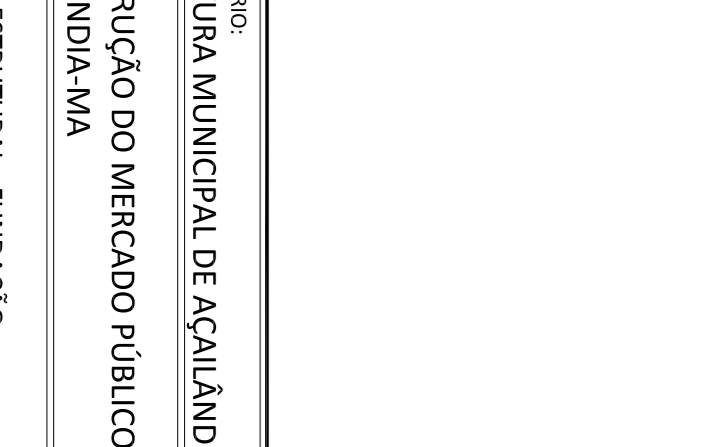

VISTA H  
ESC: 1/25

VISTA B  
ESC: 1/25

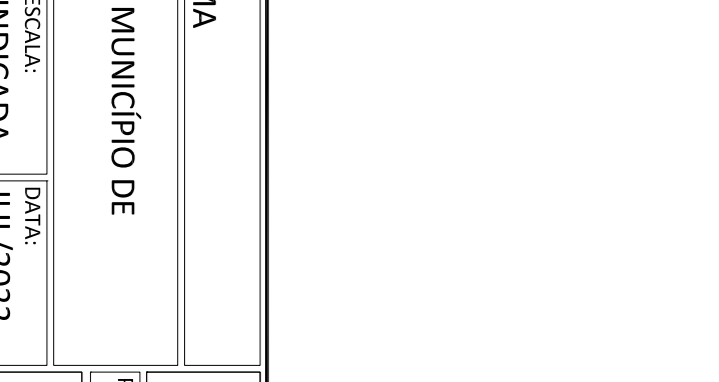

P2

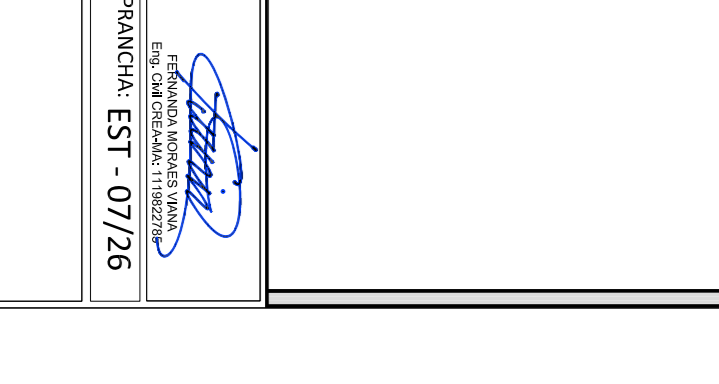

VISTA H  
ESC: 1/25

VISTA B  
ESC: 1/25

PROPRIETÁRIO:  
PREFEITURA MUNICIPAL DE AÇAILÂNDIA-MA

PROJETO:  
CONSTRUÇÃO DO MERCADO PÚBLICO NO MUNICÍPIO DE  
AÇAILÂNDIA-MA

TÍTULO:  
PROJETO ESTRUTURAL - FUNDAÇÃO

ESCALA:  
INDICADA

DATA:  
JUL/2022

PROJ. CIVIL: EST - 07/26